

Extraoral Imaging

The Orthophos family

dentsplysirona.com/orthophosfamily

Subject to technical changes and errors in the text; Order No. A91100-M47-C206-01-7600, Printed in Germany, Dispo No. 04602, OEW19 0319 VO

Clinical Procedures

Preventive
Restorative
Orthodontics
Endodontics
Implants
Prosthetics

Platform Technologies

CAD/CAM
Imaging
Treatment Centers
Instruments

Dentsply Sirona

13320-B Ballantyne Corporate Place
Charlotte, NC 28277
dentsplysirona.com



The Orthophos family for extraoral imaging

As versatile as your practice workflow, the Orthophos family ensures that you can **image, diagnose, and treat** with **confidence** while increasing case acceptance in your practice. Each of the models offer you the full expertise of Dentsply Sirona, the best image quality and programs to support your needs. From entry-level digital radiography to the highest level of specialization, you're provided with optimal support in a variety of clinical tasks.

Orthophos SL: The complete solution with the best image quality for practices that want to do more

Orthophos S: The high-performance 2D/3D X-ray unit with a comprehensive range of capabilities for every practice

Orthophos E: The preferred entry-level 2D unit for practices new to digital and looking for a great value

Here's what makes our family so unique:

Outstanding image quality

Thanks to true innovation, the Orthophos family provides impressive and unparalleled sharp images

The Direct Conversion Sensor

Our unique DCS sensor with autofocus function for images with outstanding sharpness

Our unique autofocus

The autofocus function for sharp, detailed images, even in anatomically difficult cases

The patented occlusal bite block

Maximum consistency and reproducibility in patient positioning

Our 3D offer

The appropriate volume, optional upgradability and a program for every indication (from Ø 5 cm x 5.5 cm to Ø 11 cm x 10 cm)

Fully flexible with Low Dose and HD

From 3D exposures in the dose range of a 2D X-ray, to high-definition images with a resolution of up to 80 µm





The Simple Sleep Solution

MATRx plus™ with SICAT Air and OPTISLEEP is a complete 3D solution for the analysis and appliance-based treatment of Obstructive Sleep Apnea (OSA).

The Simple Sleep Solution integrates comparative airway images using a Dentsply Sirona 3D Imaging system and expands the SICAT Air and OPTISLEEP workflow by adding MATRx plus, making it the only solution offering a complete workflow from airway analysis, diagnostics of OSA, oral appliance study, to the treatment of OSA with a custom-fitted oral appliance.



MATRx plus™

An innovative, easy-to-use tablet-based and cloud-connected home sleep testing system, MATRx plus simplifies patient selection for oral appliance therapy by identifying responders and their effective target protrusive position in advance of appliance fitting. This position and the respective jaw relation are exactly transmitted into the final appliance with SICAT Air via a fully digital workflow.

- Cloud-based connectivity streamlines sleep physician study analysis, interpretation, and OSA diagnosis
- Knowing who to treat gives your patient confidence in therapy
- Accurate prediction of target protrusion eliminates guesswork and saves chairtime
- MATRx plus comes standard with Orthophos SL 3D-Ai



Digital workflow with MATRx plus, SICAT Air, and OPTISLEEP

Modern and intuitive implantology. Your way.

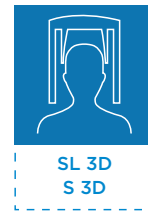

Whether you are an advanced implantologist or just getting started, SICAT Implant effectively guides you through the implantology workflow with ease and efficiency.

Featuring seamless integration between the software and hardware, you get a truly unique user experience and an effective partner for your implant workflow. SICAT Implant supports true precision and accuracy during the implant planning process, which helps the clinician to foresee any unfavorable complications prior to treatment, providing peace of mind and confidence during surgery.

In combination with the numerous surgical guide options, which can be ordered directly in the software, sent out to a local lab, or milled directly in-house with your CEREC milling unit, you are supported until the final placement of the implant.



Scan

Plan

Place

Restore



- Baseline 3D X-ray scan with a Dentsply Sirona 3D X-ray system for upper airway analysis.
 - MATRx plus system dispensed for at-home sleep test to assist in OSA diagnostics and to predict therapeutic response and target protrusive position for OPTISLEEP appliance.
- 3D X-ray scan with the patient wearing the MATRx plus titration trays at target position and capturing of the optical surface scan data of the patient's upper and lower jaw. Subsequent fusion with the 3D data within SICAT Air.
- OPTISLEEP delivery at MATRx plus target and presentation to patient including review of application and care.
 - Ordering of OPTISLEEP therapeutic appliance in a completely digital workflow.



3D endodontics

Does your practice offer endodontic treatments? This can often come with many challenges. Emergency patients that need treatment for elusive canals and unpredictable pathology are just a few of the issues that you may be faced with. 3D imaging visualizes hidden structures, reveals clinical issues and makes it possible to address each situation individually.



SL 3D
S 3D

Orthodontics

Versatility, well-chosen programs and outstanding image quality are just a few of the characteristics that make each member of the Orthophos family a perfect partner in your practice. In Orthodontics, they offer safe and efficient treatment using the ALARA principle - and support you in reaching an accurate diagnosis efficiently and with optimal clinical support. Clear case presentation helps improve overall patient communication and treatment acceptance.



Dedicated programs for young patients

The horizontally and vertically reduced children's panoramic program delivers high-definition images at the lowest dose.



All models



Ceph arm

Carpus image, PA and AP, as well as lateral ceph with the additional possibility of upper and occipital collimator for additional dose reduction.



SL 2D/3D
S 2D/3D



Quick shot function

It reduces the capture time and dose. This facilitates, for example, working with children in panoramic and ceph images.



SL 2D/3D
S 2D/3D



No more surprises

SICAT Endo is a CBCT-based software providing you the ability to create a clear map detailing the route you will take into the canal, preparing you for any difficult anatomical structures that exist through realistic and detailed information.

Your advantages at a glance:

- 3D allows you to see structures that are often hidden in 2D X-rays
- Increased diagnostic confidence
- Clearer treatment presentation to patients
- Improved practice offering and as a result, increased growth and profitability
- Eliminates the need to refer your patient out for a CBCT scan

Custom 3D image

Digital imaging offers unbeatable benefits for every dental practice, creating a new standard for quality dental care. Whether overlaid teeth, unexpected canals, hidden roots or in the case of orthodontic surgery, a lower dose option for children, 3D images are invaluable in a variety of clinical tasks. In addition, they simplify patient communication for greater acceptance of your treatment proposal.

Precisely your volume - More possibilities for your practice

When it comes to volume size, dose and image quality, every clinical case has its own individual requirements. The Orthophos family combines image quality and versatility. Choose the appropriate volume for your needs: From the focused Ø 5 cm x 5.5 cm volume to the Ø 11 cm x 10 cm volume, which can display the wisdom teeth and upper respiratory tract.

The available volumes of our 3D models at a glance:

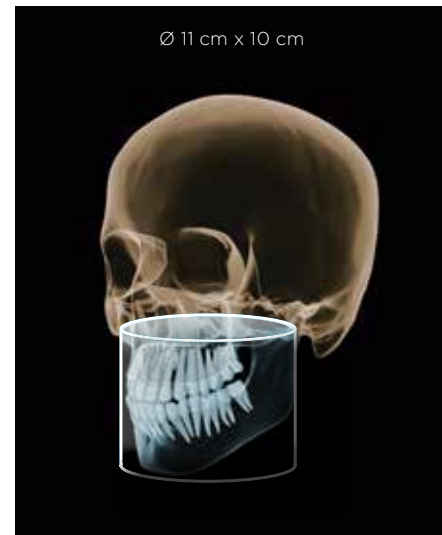
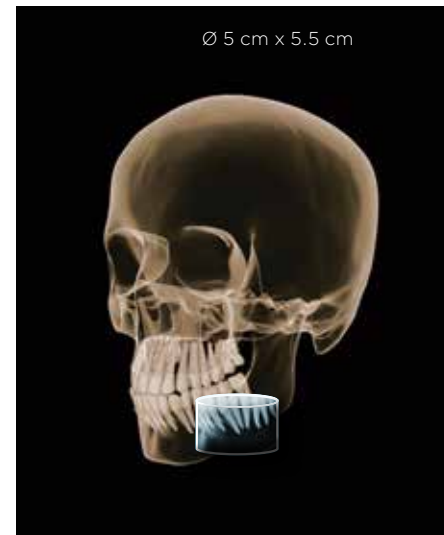

Additional available volumes (varies by model): Ø 8cm x 5.5cm, Ø 11 cm x 8 cm, Ø 11 cm x 7.5 cm



Each volume can be adjusted accordingly in three different modes to adapt to each patient's unique situation:

- High Definition (HD)
- Standard Definition (SD)
- Low Dose (Low)

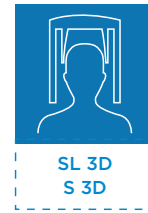

MARS - Metal Artifact Reduction Software



Metal artifacts are a challenge in 3D imaging. Radiopaque objects create shadowing and streaking effects during the three-dimensional reconstruction and as a result can often interfere with diagnostics. MARS automatically reduces metal artifacts and facilitates the diagnosis.

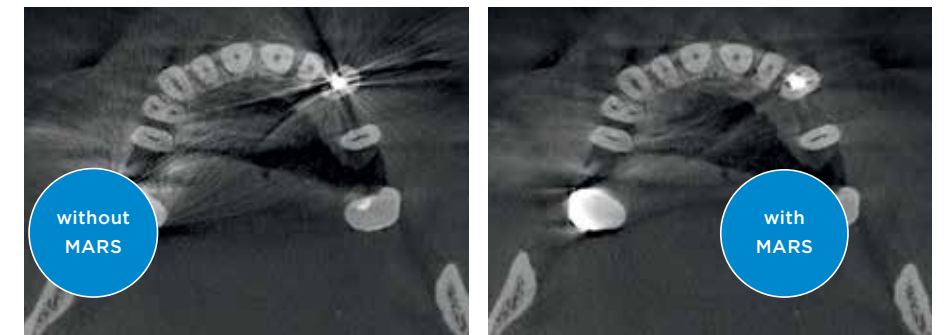

MARS keeps anatomically relevant structures as free of artifacts as possible.

High Definition Mode (HD) - Fine details for safe diagnostics



Standard Definition mode (SD) provides all of your basic clinical information needed for a diagnosis, however in some cases it's better to further increase the quality of the X-ray image. In endodontics, for example, you might need better visibility of fine structures for treatment planning and implementation. For this purpose, the Orthophos offers you High Definition mode (HD), in which up to 800 individual images are recorded during one rotation and merged into a low-noise 3D volume with high resolution of up to 80 µm. This mode guarantees a faster and safer diagnosis within the recorded volume.



Low Dose – CBCT in the dose range of a 2D image

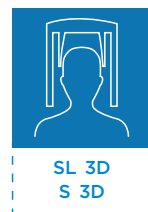

The optimized Low Dose mode with a dedicated filter allows for the imaging of dense structures, like bone, at a greatly reduced dose. This makes Low Dose an efficient option for many clinical tasks – especially for those in orthodontics or implantology. With the two 3D models in the Orthophos family, you're choosing on a case-by-case basis whether you use high-resolution volumes for fine structures (HD) or a low-dose image for minimal radiation exposure.

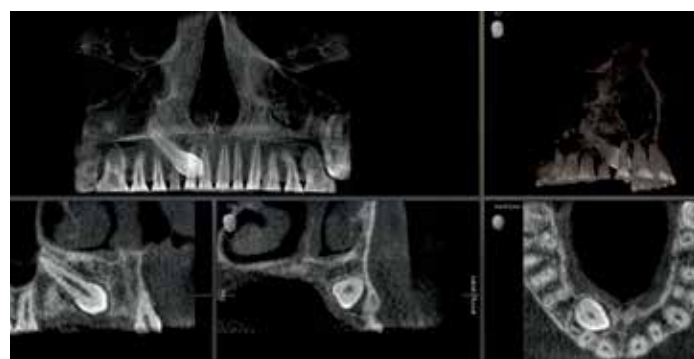

Localization of displaced incisor Ø 5 cm x 5.5 cm at 3 µSv



Tooth position determination Ø 8 cm x 8 cm at 8 µSv

Low Dose for a variety of clinical tasks

Program selection for the case-based application using the ALARA (As Low As Reasonable Achievable) principle

Tooth position determination in 3D
at low dose, especially for young, radiation-sensitive patients

Implant control in 3D
in the dose range of an intraoral X-ray

Sleep apnea therapy
with SICAT Air and OPTISLEEP



Easy operation, accurate positioning

With the Orthophos line, you capture the best possible image to support your diagnosis and maximize your patient's experience. Our models offer unique, patented solutions designed to support all of your needs. Optimize your practice's workflow with intuitive user interfaces and automatic positioning aids to avoid unnecessary secondary exposures.

Everything you need for the best image



1 Patented occlusal bite block

Position the patient with the patented occlusal bite block. The Orthophos intuitively determines the correct tilt of the head for optimal positioning and informs you through correlating symbols and colors how to adjust accordingly with just the press of the up or down arrow.



SL 3D
S 3D

2 Stable patient positioning

Stable patient positioning prevents motion blur. The motorized 3-point head fixation and sturdy handles give your patient the necessary support. The integrated temple width measurement automatically ensures a patient-specific orbit. Unnecessary downtime can be reduced by the automatic opening of the temple support for a successful X-ray outcome.



All
models

3 Intuitive use

The EasyPad, which can be swiveled and tilted to your desired position, offers you absolute flexibility and optimal support in your workflow. This is in addition to clear user options and program selections on the innovative touchpad.



SL 3D
S 3D





Designed for your patient

The Orthophos family is designed according to the ALARA principle to allow the best image at the lowest necessary dose. All programs and capture parameters are tailored to the specific diagnostic tasks and offer you more diagnostic options and a particularly fast capture procedure.

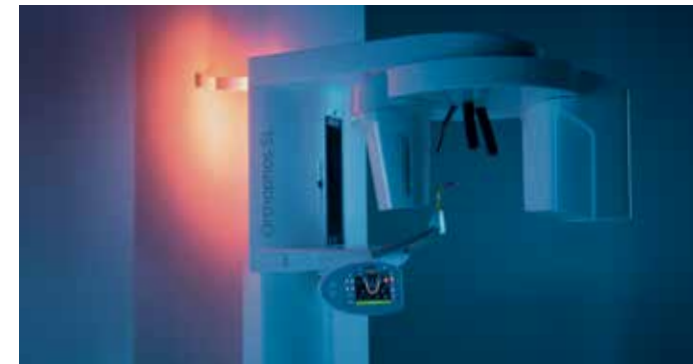

With a selection of over 30 colors, the Orthophos SL **Ambient Light** creates a pleasant atmosphere for your patient and blends in perfectly with your modern practice look.



All Orthophos models allow for **wheelchair accessible** patient positioning.

On the Orthophos positioning tools:

“Our whole team gets along very well with the positioning. The many useful features such as automatic light localizers, luminous height adjustment buttons and the intuitive program selection allow us to work efficiently – and with very good image quality. Combined with the Sidexis 4 software, the Orthophos gives us absolute confidence in the findings.”

PD Dr. Dr. Lutz Ritter, Maxillofacial Surgery, Hennef

Your advantages at a glance:

- Outstanding image quality at the lowest dose
- Optimized workflow
- Simplified diagnostics through a variety of analysis tools
- By eliminating the need for a darkroom you free up valuable office space
- No toxic chemicals for developing images
- Better patient education and understanding
- Improved marketing of practice services

Digital images in 2D

Lower radiation exposure and excellent images are associated with more efficient data management. When working digitally you have the ability to discuss your diagnosis, treatment methods and the services provided by your practice all completely chairside, allowing for a more attentive patient experience.

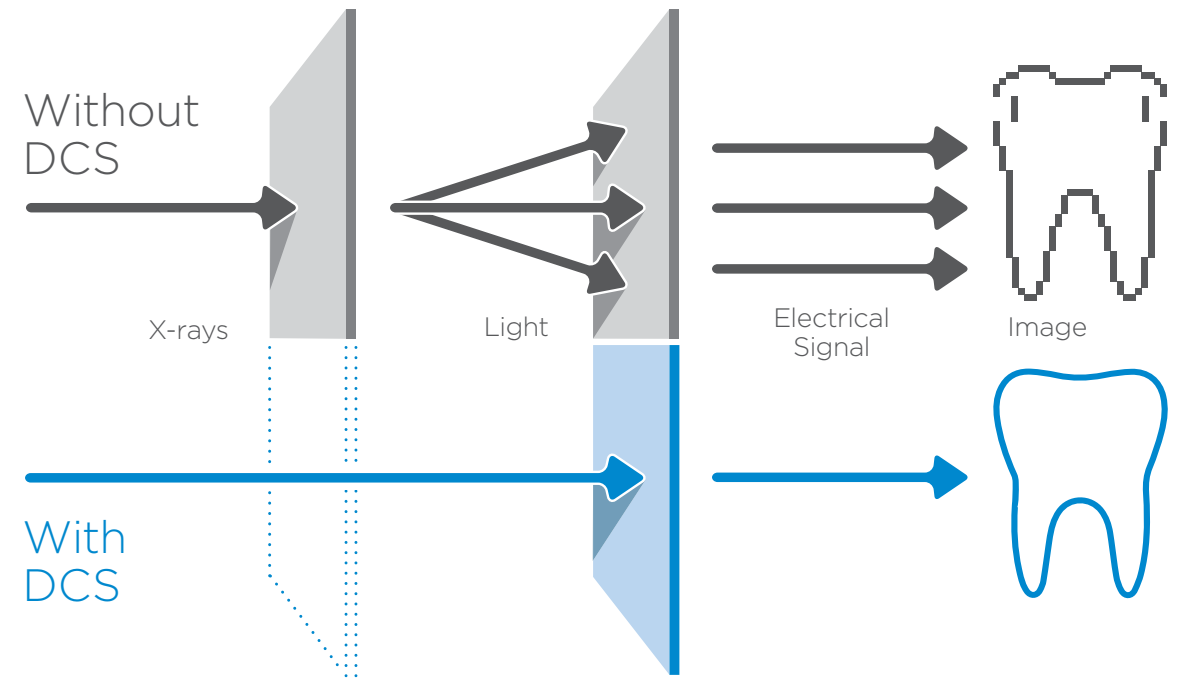

DCS – Sharpness for fine details

The Direct Conversion Sensor (DCS) has redefined the standard of panoramic imaging. X-rays are converted directly into electrical signals – unlike conventional systems, there is no signal loss due to light conversion. The resulting images have a high level of sharpness and detail, providing optimal clinical information for your diagnosis.

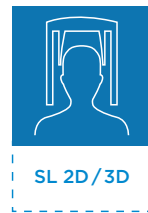

Extraoral Bitewing

With all Orthophos models, you can use the bitewing function to create extraoral bitewing images with an optimized curve for the posterior tooth region. With the image field selection you can focus on the area of interest.



Autofocus – Automatically the best image

In order to get a sharp panoramic X-ray image with high definition, the right focus is essential. The jaw must be in the sharp image layer of the device. For this, the Orthophos creates several thousand individual images in one rotation and automatically recognizes the areas in which the jaw is optimally positioned. These are displayed in an overall sharp image – without any manual intermediate steps.

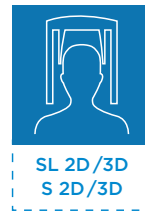

Autofocus in Orthophos SL/S without manual steps such as the selection of images or the positioning of an incisor laser light. The device automatically and optimally brings all areas of the jaw into focus.

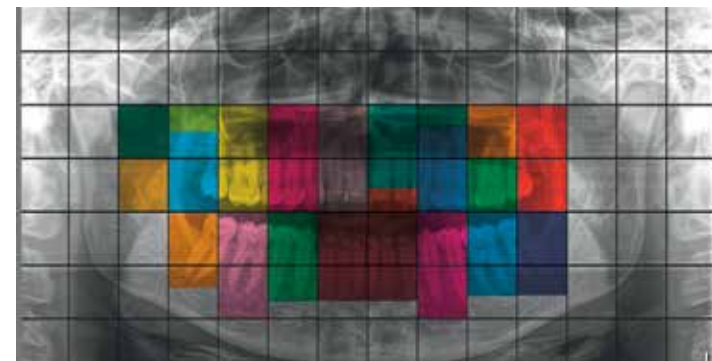

A sharp image is automatically calculated



The result is images in maximum sharpness

All 2D programs at a glance

Digital imaging offers you a full range of applications. Here you will find an overview of all 2D programs:

Programs*	Orthophos E	Orthophos S	Orthophos SL
Standard panorama image	P1, P10	P1, P2, P10	P1, P2, P10
Image detail left side or right side	P1L, P1R	P1, P1A, P1C P2, P2A, P2C P10, P10A, P10C BW1	P1, P1A, P1C P2, P2A, P2C P10, P10A, P10C BW1
Image detail individual quadrants	-	P1, P1A, P1C P2, P2A, P2C P10, P10A, P10C	P1, P1A, P1C P2, P2A, P2C P10, P10A, P10C
Image detail upper or lower jaw	-	P1, P1A, P1C P2, P2A, P2C P10, P10A, P10C, P12	P1, P1A, P1C P2, P2A, P2C P10, P10A, P10C, P12
Constant magnification	P1C	P1C, P2C, P10C	P1C, P2C, P10C
Artifact-reduced	P1A	P1A, P2A, P10A	P1A, P2A, P10A
Thick layer front	P12	P12	P12
Sinus	S1	S1, S3	S1, S3
Multislice of premolars	MS1	-	-
Temporomandibular Joint	TM1.1, TM1.2	TM1.1, TM1.2, TM3	TM1.1, TM1.2, TM3
Bitewing image	BW1	BW1, BW2	BW1, BW2
Ceph (optional)	C1, C2, C3, C3F, C4	C1, C2, C3, C3F, C4	C1, C2, C3, C3F, C4

* for image samples see page 38-39

Sidexis 4 software

Whether 2D or 3D – brilliant images are only truly at their best when displayed in the right software. The modern and highly intuitive imaging software, Sidexis 4, supports clear diagnosis. With its award-winning user interface, it promotes an accessible workspace and clear navigation, saving valuable practice time. The clear platform also creates a basis for optimal patient communication, increasing comfort and understanding – a strong foundation for trust.



Integrated Workflows

Sidexis 4 can be easily integrated into your practice and intuitively operated without a lot of training. Sidexis 4 also offers expansion possibilities beyond the image field, keeping your practice equipped for growth and opportunity.

Modern, intuitive design

Sidexis 4 offers a completely new, updated look. Beyond the impressive aesthetics, the new software also boasts an intuitive operating approach and clear design. The new timeline function also offers you an easy-to-navigate patient diagnosis and treatment history.

Seamless 2D/3D

With Sidexis 4, you can view 2D and 3D data simultaneously and side by side without switching between programs. This saves you valuable time and cross-comparisons provide you with increased confidence in your final diagnosis and treatment plan.

Compare

Sidexis 4 compares two CBCT images or up to four 2D images simultaneously. For example, you can navigate through both volumes at the same time, obtain cross-comparisons at a glance and provide clear patient communication and case presentation.

Mobile image visualization with the Sidexis iX iPad app

Whether changing treatment rooms or explaining your diagnosis directly on the image – with Sidexis iX, you can take images with you wherever you go, making the iPad a convenient and accessible advisory tool.



3D imaging to go

so you can use all the mobile and flexible advantages of the iPad

Implant visualization

to clearly and precisely present your implant treatment proposal to the patient

Sidexis 4 Databank Access

providing the complete use of the Sidexis 4 databank and available offline copies

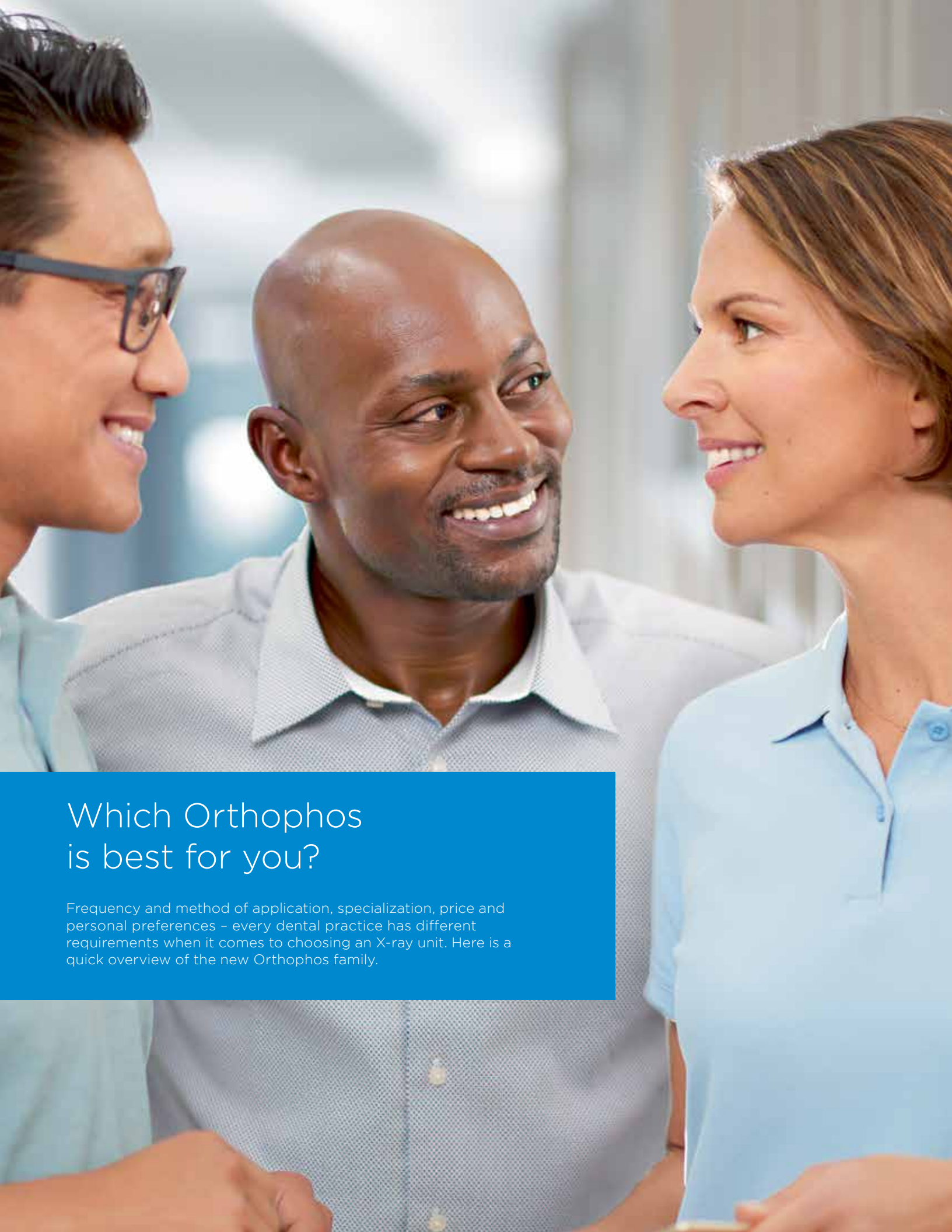

Which Orthophos is best for you?

Frequency and method of application, specialization, price and personal preferences – every dental practice has different requirements when it comes to choosing an X-ray unit. Here is a quick overview of the new Orthophos family.

Orthophos E



The preferred entry-level unit for a smooth entrance into the world of digital imaging.

Unit variants
Orthophos E 2D

Patient positioning
Manual

Panoramic technology
Csl sensor

Orthophos S



The reliable 2D/3D solution with a comprehensive performance spectrum in 2D and 3D – optimized for everyday tasks in the field.

Unit variants
Orthophos S 2D
Orthophos S 3D
Optional Ceph, left or right
3D-FoV Ø 5x5.5-Ø 11x10

Patient positioning
Automatic

Panoramic technology
Csl Plus sensor
Autofocus

+ Autofocus
+ Occlusal bite block

Orthophos SL



The complete solution with the best image quality for practices with a grasp of the latest technologies – and for those who simply want more.

Unit variants
Orthophos SL 2D
Orthophos SL 3D
Optional Ceph, left or right
3D-FoV Ø 5x5.5-Ø 11x10

Patient positioning
Automatic

Panoramic technology
DCS sensor
Autofocus

+ DCS
+ Ambient Light

2D

2D/3D

Orthophos SL

2D/3D imaging system

The complete system for practices providing treatment solutions for nearly all clinical situations.

The integrated Direct Conversion Sensor (DCS) completely redefines the standard of panoramic imaging – delivering unparalleled sharpness. The letters “SL” stand for Sharp Layer technology, which provides highly detailed panoramic images, even in difficult cases. The Orthophos SL guarantees maximum ease of use through automatic positioning, intuitive operation with the EasyPad and a customizable ambient light with 30 color options for an exclusive look and feel in your practice.

For those who want to do more

Services and Functions

1

Unique DCS sensor

For outstanding, high-quality images

2

Sharp layer technology

For presentation in detailed sharpness, and the possibility for subsequent object focusing

3

Low Dose and HD function

3D imaging in the dose range of a 2D X-ray, HD images with up to 80 μm resolution

4

Autopositioning with the occlusal bite block and EasyPad

For consistent panoramic imaging results without the need of the Frankfurt Horizontal for positioning guidance

5

Comprehensive panoramic and cephalometric programs

For bitewing, sinus or ceph images, left or right ceph arms are optional and can be retrofitted at any time

6

Safe and proven patient positioning

With motorized temple and forehead supports, automatic temple width measurement, light localizers and sturdy handles

7

Coordinated volume sizes

From \varnothing 5 cm x 5.5 cm to \varnothing 11 cm x 10 cm

8

Ambient Light

Over 30 color options for a pleasant atmosphere



Outstanding image quality thanks to the DCS sensor and Sharp Layer technology.

Orthophos S

2D/3D imaging system

The high-quality 2D/3D X-ray unit with a comprehensive range of services for every practice. Whether used as a pure 2D device or including a 3D module – the Orthophos S is a reliable partner and optimized for daily practice tasks. Thanks to the CSI Plus sensor with autofocus function, you are assured sharp images every time, even in anatomically difficult cases. The patented occlusal bite block assures proper patient positioning and accurate imaging. For use in orthodontics, the Orthophos S is also available with an optional cephalometric arm. And because future-proofing is a priority at Dentsply Sirona, the cephalometric arm and 3D upgrade can be retrofitted at any time.

Optimized for the everyday tasks in your practice

Services and Functions

1 2D CSI Plus sensor with autofocus function

For sharp, detailed images, even in anatomically difficult cases

2 Coordinated volume sizes

From Ø 5 cm x 5.5 cm to Ø 11 cm x 10 cm

3 Low Dose and HD function

3D imaging in the dose range of a 2D X-ray, HD images with up to 80 µm resolution

4 Patented occlusal bite block for automatic positioning

Maximum consistency and reproducibility, thanks to automatic patient positioning

5 Cephalometric arm on the left or right

This can be ordered at the time of purchase or can be retrofitted at any time

6 Safe and proven patient positioning

With motorized temple and forehead supports, automatic temple width measurement, light localizers and sturdy handles



Sharp images thanks to the CSI Plus sensor and autofocus

Orthophos E

2D imaging system

The preferred 2D X-ray device. The entry-level unit provides a smooth entrance into the world of digital imaging through reliable diagnostics, thanks to CsI sensor technology and easy operation.. Enrich your practice with a wide range of offerings that are only possible with digital imaging.

For a smooth entrance into digital imaging

Services and Functions

1 2D CsI sensor

For an accurate diagnosis, thanks to reliable image quality

2 Important 2D programs

For comprehensive diagnostics with a motorized collimator, allowing for true pediatric programs

3 Safe and proven patient positioning

With motorized temple and forehead supports, automatic temple width measurement, light localizers and sturdy handles

4 MultiPad control panel

For clear and simple operation

5 Templesupport and bite block

Two patented, differentiating solutions providing patient specific rotation and easier positioning

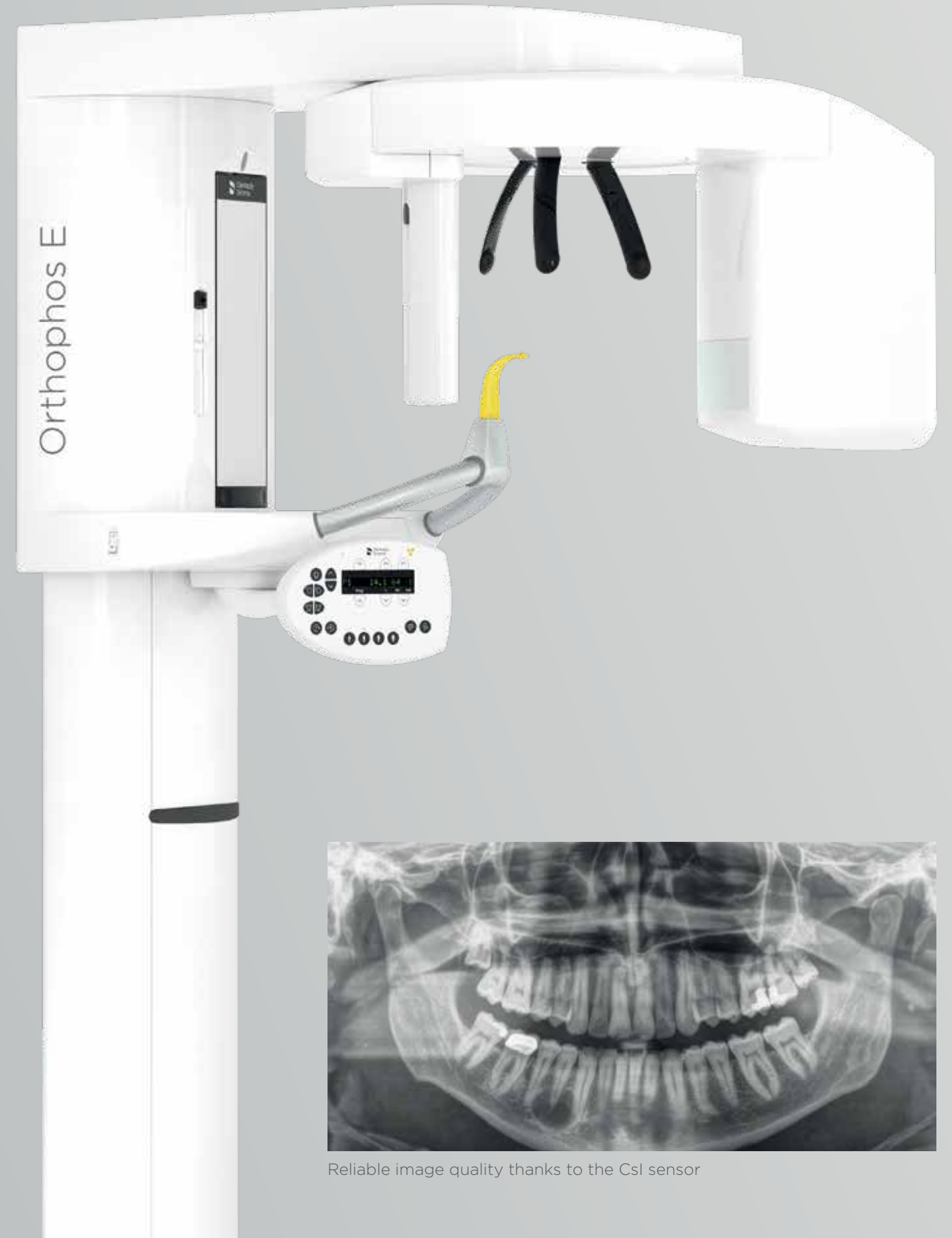

Reliable image quality thanks to the CsI sensor

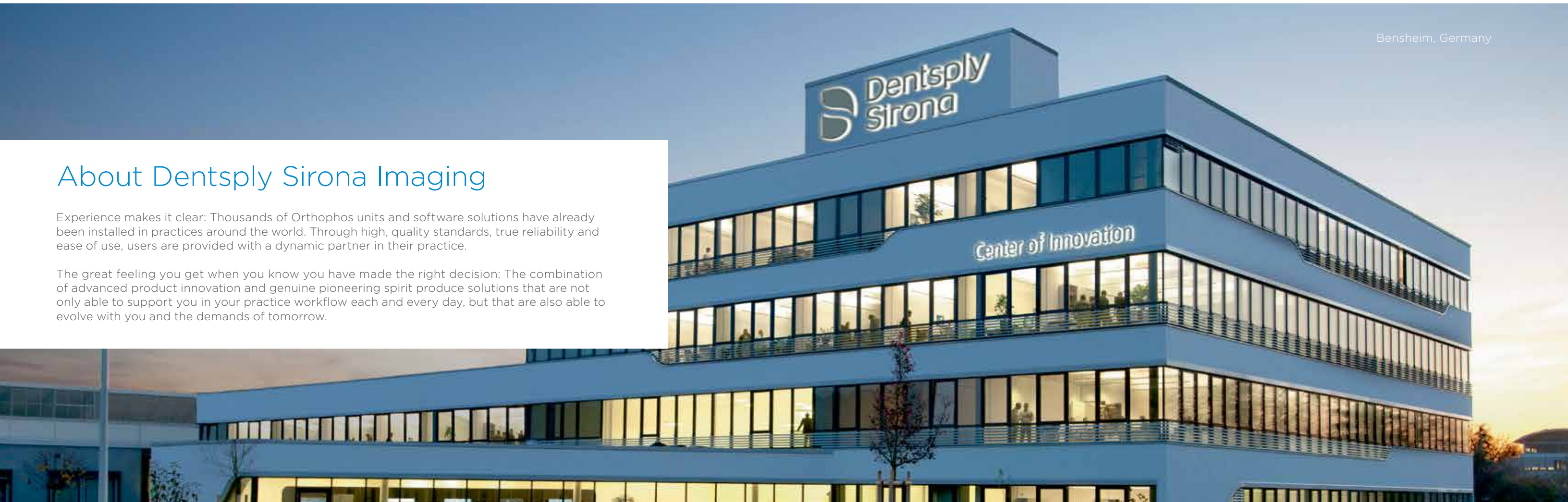
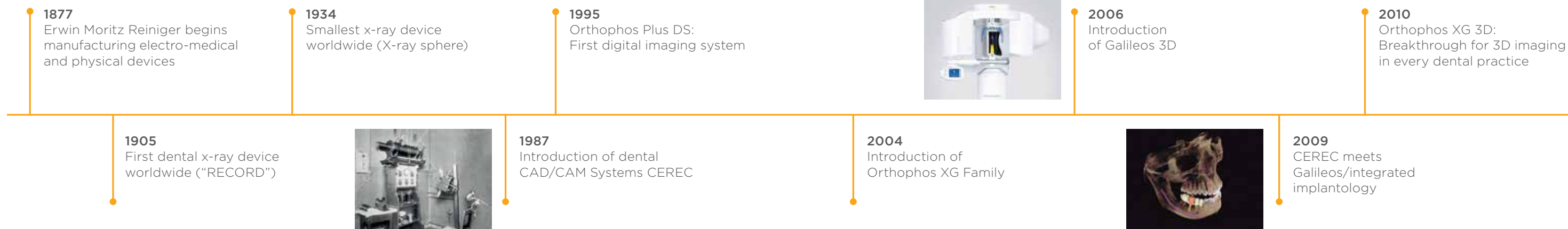

Bensheim, Germany

About Dentsply Sirona Imaging

Experience makes it clear: Thousands of Orthophos units and software solutions have already been installed in practices around the world. Through high, quality standards, true reliability and ease of use, users are provided with a dynamic partner in their practice.

The great feeling you get when you know you have made the right decision: The combination of advanced product innovation and genuine pioneering spirit produce solutions that are not only able to support you in your practice workflow each and every day, but that are also able to evolve with you and the demands of tomorrow.



2012
Schick 33 Sensors: HD image quality for intraoral x-ray



2015
Introduction of Orthophos SL - The comprehensive imaging solution for each practice

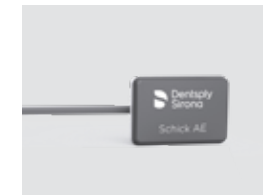

2019
Introduction of Schick AE intraoral sensor with Advanced Exposure technology



2015
Introduction of Sidexis 4 - The new gold standard & heart of the Dentsply Sirona workflow



2017
Introduction of Low Dose mode for Orthophos SL 3D



2019
Introduction of the new Orthophos family

The Orthophos family: Technical properties overview

Performance features	Orthophos E 2D	Orthophos S 2D	Orthophos SL 2D	Orthophos S 3D	Orthophos SL 3D
X-ray generator	60-90 kV, 3-16 mA	60-90 kV, 3-16 mA	60-90 kV, 3-16 mA	60-90 kV, 3-16 mA	60-90 kV, 3-16 mA
Panoramic exposure time	P1 14.2 s max.	P1: max 14.2 s P1 Quickshot: max 9.1 s	P1: max 14.2s P1 Quickshot: max 9.1 s	P1: max 14.2 s P1 Quickshot: max 9.1 s	P1: max 14.2 s P1 Quickshot: max 9.1 s
Radiation time Ceph	-	Standard 9.4 s Quickshot 4.7 s	Standard 9.4 s Quickshot 4.7 s	Standard 9.4 s Quickshot 4.7 s	Standard 9.4 s Quickshot 4.7 s
User interface	MultiPad	EasyPad	EasyPad	EasyPad	EasyPad
Patient positioning	manual	automatic (occlusal bite block)	automatic (occlusal bite block)	automatic (occlusal bite block)	automatic (occlusal bite block)
Panorama technology	Csl	Csl Plus	DCS	Csl Plus	DCS
Autofocus	-	yes	yes	yes	yes
Ceph arm (optional)	-	left or right	left or right	left or right	left or right
Ceph unit with 2 sensors	optional	yes	yes	yes	yes
Quickshot	-	yes	yes	yes	yes
Fields of View	-	upgradeable	upgradeable	5x5 to 8x8 5x5 to 11x10	5x5 to 8x8 5x5 to 11x10
3D Low Dose	-	upgradeable	upgradeable	yes	yes
HD mode	-	upgradeable	upgradeable	yes	yes
Base	optional	optional	optional	optional	optional
Wheelchair accessible	yes	yes	yes	yes	yes
Remote control	optional	optional	optional	optional	optional
Ambient Light	-	-	yes	-	yes



Base (optional)



Remote release with display of the capture parameters (optional)

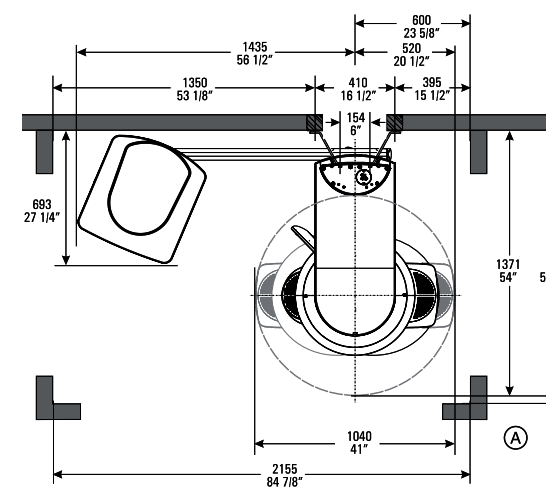
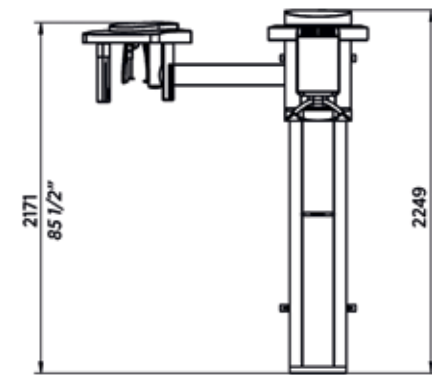
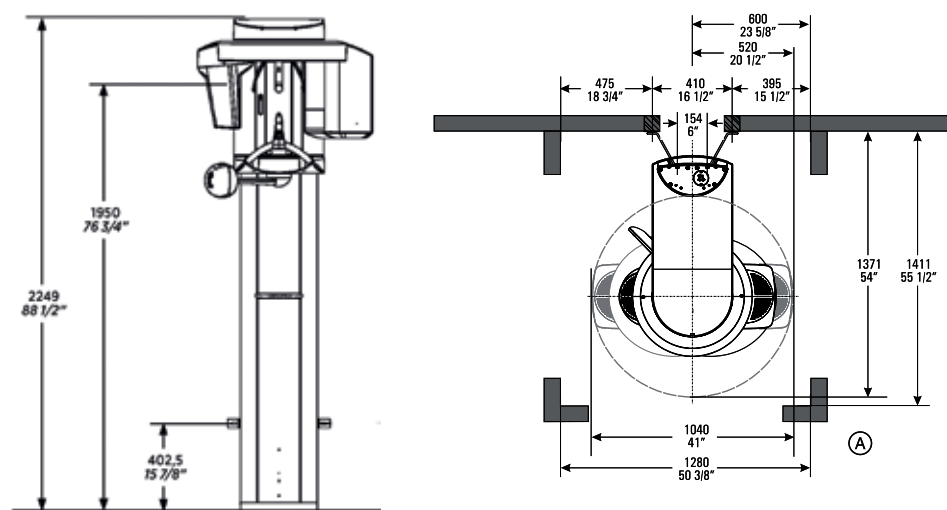

Recommended room dimensions:

- Orthophos: space required 1,280 mm x 1,411 mm,
- Orthophos with ceph side arm: space required 2,155 mm x 1,411 mm

All further measurements you will find in the according installation requirements.

The image spectrum of the Orthophos family

Panorama



P1 full size orthogonal panoramic view



P2 without ascending rami

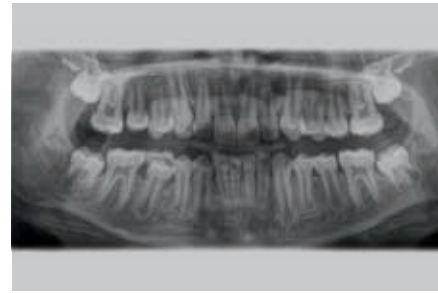

P10 pediatric panorama, beam field reduced in height and length

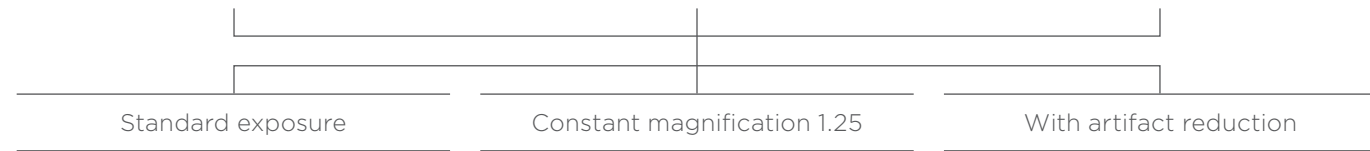

Optional panning:

Upper jaw, lower jaw, Left, Right, Individual quadrants



P12 thick slice in anterior tooth region

Optional panning:

Upper jaw, lower jaw

Bite wing

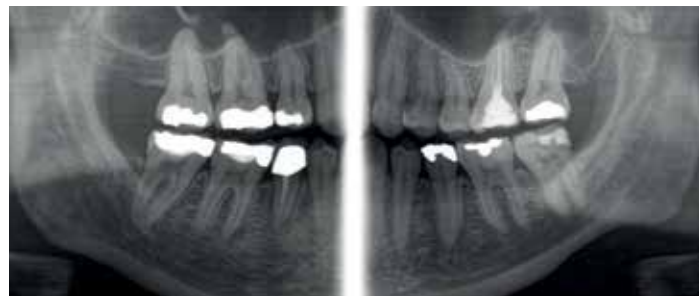

BW1

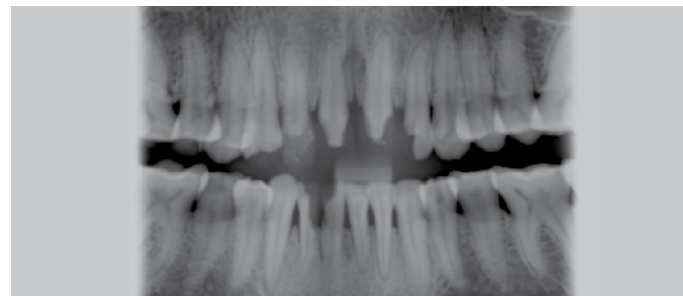

BW2 anterior tooth region

Optional panning:

TMJ

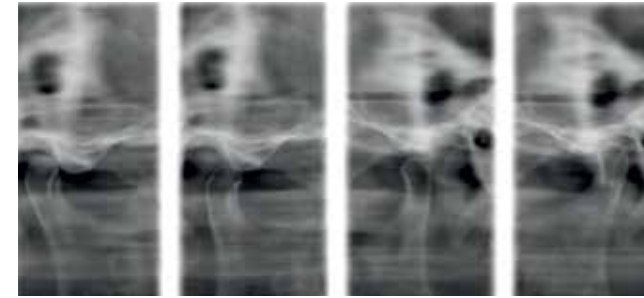

TM1 lateral

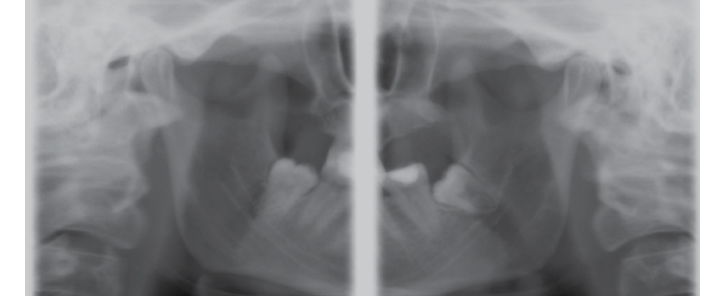

TM3

Adjustable radiation angle:
With open and closed occlusion, with a slice position

Sinus

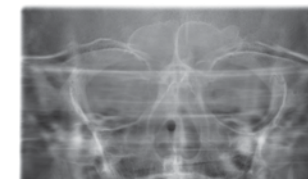

S1 jaw cavities

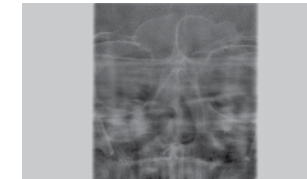

S3 simple jaw cavities linear

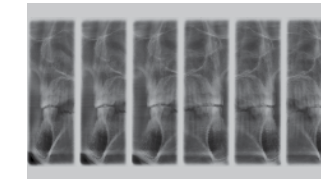

MS1

Multislice in posterior tooth region

Examples of possible applications in your practice



Ø 5 cm x 5.5 cm HD volume

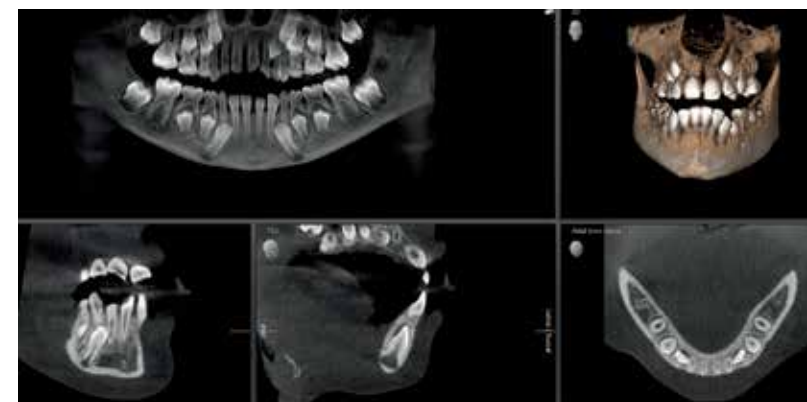

Ø 8 cm x 8 cm image in low dose mode with 15 µSv

PC Requirements

Requirements for image acquisition computer

Orthophos	S 3D / SL 3D	S 2D / SL 2D	E
Operating system	Windows 7 Professional/Ultimate (64 bit) Windows 8.1 Professional (64 bit) Windows 10 Version (64 bit)		See requirements for Sidexis 4 2D workstation
CPU	≥ 2.3 GHz QuadCore with SSE3 support (Intel > i7-3xxx or similar)	SL*: > 2.3 GHz QuadCore with SSE3 support (Intel > i7-3xxx or similar) S: > Intel i3 3rd generation or similar	
RAM	16 GB		
Hard drive	> 1 TB of free hard drive capacity		
Graphics card	DirectX 11 graphics card (2 GB of dedicated RAM) with the current graphics card drivers (a list of tested graphics adaptors can be found in the Dentsply Sirona retailer section)	SL*: DirectX 10 graphics card (1 GB of dedicated RAM or Intel Onboard graphic with current graphics driver) S: DirectX 9.0c graphic card (512 MB of deidcated RAM or Intel Onboard Graphcs with current graphic card drivers)	
Screen resolution	Minimum 1280 x 1024 pixels 1600 x 1200 pixels are recommended		

* with panorama editor

Requirements for the Sidexis 4

PC Workstation	Sidexis-Server	Min. for 2D Station	Min. for 3D Station
Operation system*	Windows Server 2008 R2 Windows Server 2012 R2 Windows Server 2016 Windows 7 Pro SP1 (64 bit) Windows 8.1 Pro (64 bit) Windows 10 Pro (64 bit)	Windows 7 Pro SP1 (32 or 64 bit) Windows 8.1 Pro (64 bit) Windows 10 Pro (64 bit)	Windows 7 Pro SP1 (64 bit) Windows 8.1 Pro (64 bit) Windows 10 Pro (64 bit)
CPU	≥ 2.3 GHz QuadCore Processor with 64 bit (x64)	≥ 2 GHz DualCore	≥ 2.3 GHz QuadCore Processor with 64 bit (x64)
RAM	≥ 8 GB	≥ 4 GB	≥ 8 GB
Graphics memory**	≥ 1 GB	≥ 512 MB	≥ 1 GB
DirectX	DirectX 10 with WDDM 1.0 or higher driver	DirectX 9.0c	DirectX 10 with WDDM 1.0 or higher driver
Hard drive	> 1 TB	≥ 5 GB	≥ 5 GB

* installation for 64 bit - operating systems is also approved using Bootcamp

** so that the interaction with the volumes generated in 3D remain reliably "stable", graphics cards with at least the following PassMark GPU benchmark values are recommended: NVIDIA PassMark > 1000. AMD PassMark > 1500. 1500 Onboard > 540

Further information at www.sidexis.com/systemrequirements.
System requirements for the used hardware may vary.

Dentsply Sirona Imaging

With Imaging Systems from Dentsply Sirona, you can trust in experience that provides safety. As the frontrunner in dental imaging for more than 120 years, our solutions provide unparalleled diagnostic image quality at the lowest reasonable dose, while being intuitive and easy to use. They can be used to support all dental disciplines, integrated imaging systems and software to enable truly better, safer and faster procedures.

